

Altivar 61 / 71

User's manual

Profibus DPv1

Retain for future use

VW3 A3 307 S371

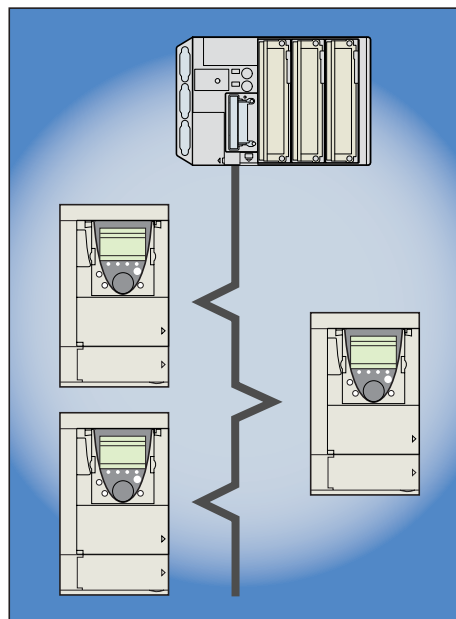

Contents

Before you begin	4
Documentation structure	5
Introduction	6
Presentation	6
Notation	6
Hardware setup	7
Receipt	7
Installing the card in the drive	7
Connection to the bus	8
Recommendations	9
Configuration	10
Configuring the switches	10
Control-signal configuration	12
Configuring PZDs (communication scanner)	15
Configuring communication fault management	16
Configuring monitored parameters	17
Diagnostics	18
Controlling the address and speed of the bus	18
LEDs	18
Control-signal diagnostics	19
Communication faults	22
Card fault	22
Software setup of DPv1 messaging	23
Profibus DPv1 protocol	23
Indirect access (use of SLOT 1 only)	24
Direct access (using the SLOT INDEX)	25
Software setup of DPv0 messaging	26
Output PZDs	26
Input PZDs	27
PKW aperiodic service	28
Software setup using PL7	30
Example with SIMATIC Manager (STEP7)	31

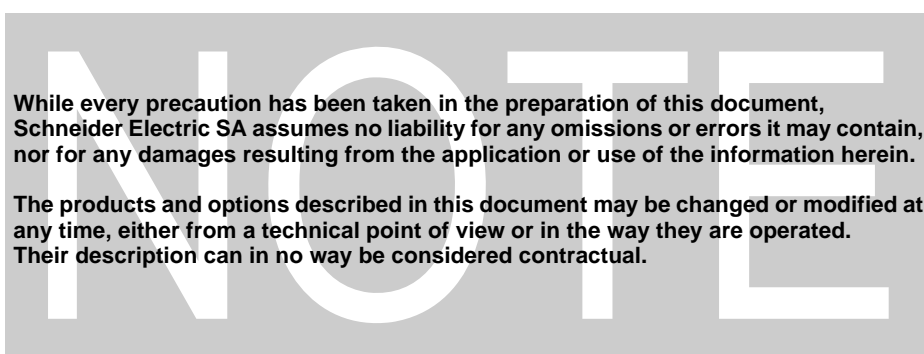

Before you begin

Read and understand these instructions before performing any procedure with this drive.

DANGER

HAZARDOUS VOLTAGE

- Read and understand this manual before installing or operating the drive. Installation, adjustment, repair, and maintenance must be performed by qualified personnel.
- The user is responsible for compliance with all international and national electrical standards in force concerning protective grounding of all equipment.
- Many parts in this variable speed drive, including printed wiring boards, operate at line voltage. DO NOT TOUCH. Use only electrically insulated tools.
- DO NOT touch unshielded components or terminal strip screw connections with voltage present.
- DO NOT short across terminals PA and PC or across the DC bus capacitors.
- Install and close all covers before applying power or starting and stopping the drive.
- Before servicing the variable speed drive:
 - Disconnect all power
 - Place a "DO NOT TURN ON" label on the variable speed drive disconnect
 - Lock the disconnect in the open position
- Disconnect all power including external control power that may be present before servicing the drive. WAIT 15 MINUTES for the DC bus capacitors to discharge. Then follow the DC bus voltage measurement procedure given in the Installation Manual to verify that the DC voltage is less than 45 Vdc. The drive LEDs are not accurate indicators of the absence of DC bus voltage.

Electric shock will result in death or serious injury

CAUTION

DAMAGED EQUIPMENT

Do not operate or install any drive that appears damaged.
Failure to follow this instruction can result in equipment damage.

Documentation structure

Installation manual

This manual describes:

- How to assemble the drive
- How to connect the drive

Programming manual

This manual describes:

- The functions
- The parameters
- How to use the drive display terminal (integrated display terminal and graphic display terminal)

Communication parameters manual

This manual describes:

- The drive parameters with specific information (addresses, formats, etc.) for use via a bus or communication network
- The operating modes specific to communication (status chart)
- The interaction between communication and local control

Modbus, CANopen, Ethernet, Profibus, INTERBUS, Uni-Telway, FIPIO, Modbus Plus, DeviceNet ... manuals

These manuals describe:

- Connection to the bus or network
- Configuration of the communication-specific parameters via the integrated display terminal or the graphic display terminal
- Diagnostics
- Software setup
- The communication services specific to the protocol

ATV58-58F/ATV71 compatibility manual

This manual describes the differences between the Altivar 71 and the Altivar 58/58F.

It explains how to replace an Altivar 58 or 58F, including how to replace drives communicating on a bus or network.

Introduction

Presentation

The Profibus DP communication card (catalog number VW3A A3 307 S371) is used to connect an Altivar 61 / 71 drive to a Profibus DPv1 bus.

Data is exchanged in order to make use of all the Altivar 61 / 71 functions:

- Configuring functions
- Uploading adjustment parameters
- Control-signaling
- Monitoring
- Diagnostics

The card has a 9-pin female SUB-D connector for connection to the Profibus DPv1 bus.

The connector and cable for connection to the Profibus DPv1 bus must be ordered separately.

Notation

Drive terminal displays

The graphic display terminal menus are shown in square brackets.

Example: **[1.9 COMMUNICATION]**.

The integrated 7-segment display terminal menus are shown in round brackets.

Example: **(COM-)**.

Parameter names are displayed on the graphic display terminal in square brackets.

Example: **[Fallback speed]**

Parameter codes are displayed on the integrated 7-segment display terminal in round brackets.

Example: **(LFF)**.

Formats

In this manual, hexadecimal values are written as follows: 16#.

Hardware setup

Receipt

- Check that the card catalog number marked on the label is the same as that on the delivery note corresponding to the purchase order.
- Remove the option card from its packaging and check that it has not been damaged in transit.

Presentation

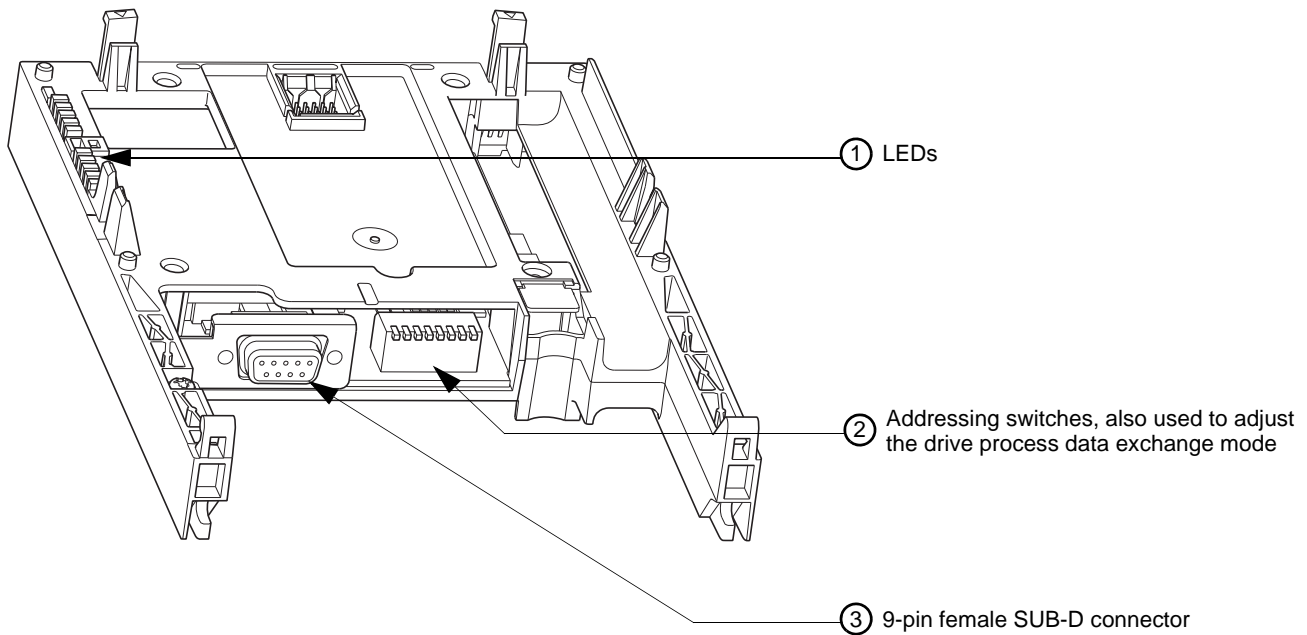

Installing the card in the drive

See the Installation Manual.

Hardware setup

Connection to the bus

Connector pinout

The transmission interface conforms to the RS 485 standard and is electrically isolated from the drive.

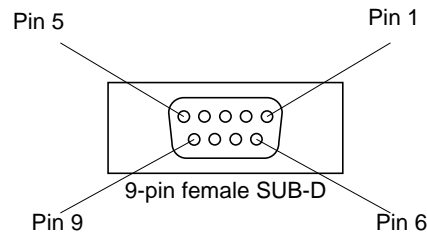

Pin	Signal	Pin	Signal	Pin	Signal
1	Not connected	4	Not connected	7	Not connected
2	Not connected	5	DGND (Ground)	8	RxD/TxD-P (Reception/Transmission +)
3	RxD/TxD-N (Reception/Transmission -)	6	VP (5 volts)	9	Not connected

Connection accessories

Profibus DP bus connection elements

Description	Used	Catalog number
Connectors	With line terminator	490 NAD 911 03
	Intermediate connection	490 NAD 911 04
	Intermediate connection and connector port	490 NAD 911 05

Profibus DP bus connection cables

Description	Length	Catalog number
Profibus DP connection cables	100 m	TSX PBS CA 100
	400 m	TSX PBS CA 400

Example of connection:

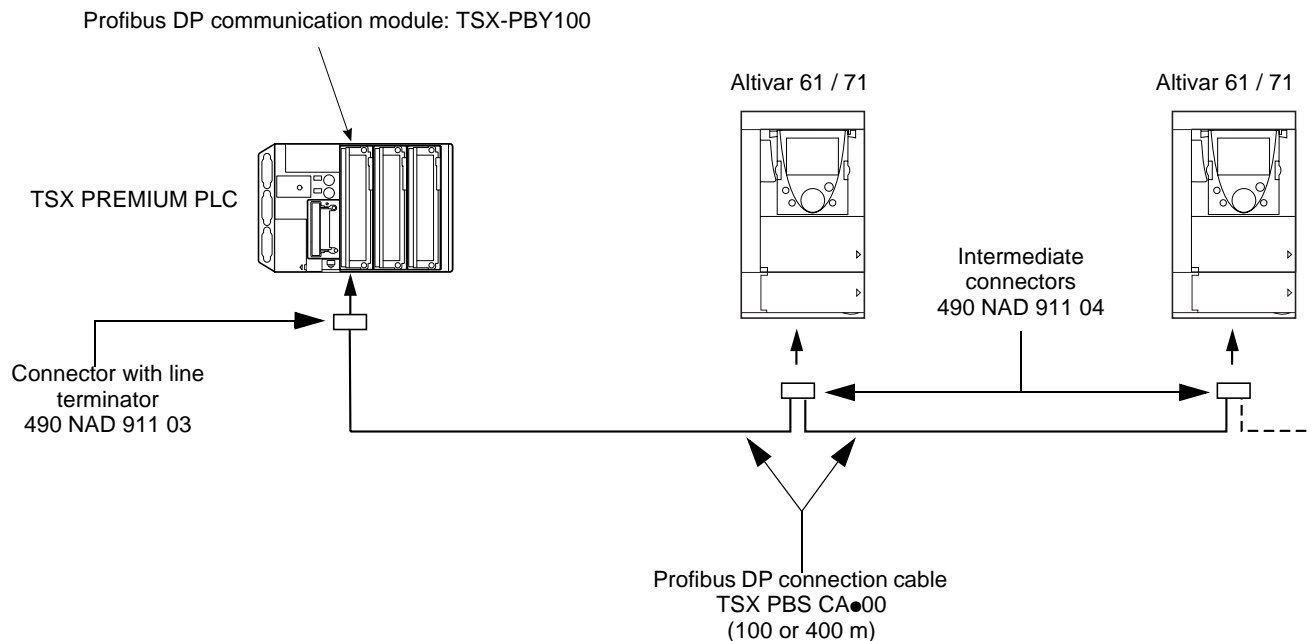

Hardware setup

Recommendations

- The user can select the data rate from a range of 9.6 kbps to 12 Mbps. This selection, made when starting up the network, applies to all the bus subscribers.
- The maximum segment length is in inverse proportion to the data rate.

Data rate (kbps)	9.6	19.2	93.75	187.5	500	1500	3000	6000	12000
Distance/segment (m)	1200	1200	1200	1000	400	200	100	100	100

Repeaters can be used to cover greater distances.

- The bus ends with a line terminator at each end of the segment.
- Do not connect more than 32 stations per segment without a repeater, or more than 127 with a repeater.
- Keep the bus away from the power cables (clearance of at least 30 cm).
- If it is necessary for power cables to cross each other, be sure they cross at right angles.

Configuration

Configuring the switches

Note:

A new configuration of the switches (address and mode) will only be applied after the next power on of the drive.

Selecting the operating mode

The switch furthest to the left is used to determine the type of cyclic exchanges performed by the drive:

- Switch 0 (OFF): Altivar 61 / 71 mode
- Switch 1 (ON): Altivar 58 compatibility mode

This manual only describes Altivar 61 / 71 mode. To find out about Altivar 58 compatibility mode, refer to the ATV58-58F/ATV71 migration manual.

Configuration

Coding the drive address

An Altivar 61 / 71 is identified on the bus by its address, coded between 0 and 126.

The address corresponds to the binary number given by position 0 (up/OFF) or 1 (down/ON) of the 7 switches on the right of the card.

The least significant bits are on the right.

The table below indicates the positions of the switches for all configurable addresses:

Addr.	Switches	Addr.	Switches	Addr.	Switches	Addr.	Switches
0	0000 0000	32	0010 0000	64	0100 0000	96	0110 0000
1	0000 0001	33	0010 0001	65	0100 0001	97	0110 0001
2	0000 0010	34	0010 0010	66	0100 0010	98	0110 0010
3	0000 0011	35	0010 0011	67	0100 0011	99	0110 0011
4	0000 0100	36	0010 0100	68	0100 0100	100	0110 0100
5	0000 0101	37	0010 0101	69	0100 0101	101	0110 0101
6	0000 0110	38	0010 0110	70	0100 0110	102	0110 0110
7	0000 0111	39	0010 0111	71	0100 0111	103	0110 0111
8	0000 1000	40	0010 1000	72	0100 1000	104	0110 1000
9	0000 1001	41	0010 1001	73	0100 1001	105	0110 1001
10	0000 1010	42	0010 1010	74	0100 1010	106	0110 1010
11	0000 1011	43	0010 1011	75	0100 1011	107	0110 1011
12	0000 1100	44	0010 1100	76	0100 1100	108	0110 1100
13	0000 1101	45	0010 1101	77	0100 1101	109	0110 1101
14	0000 1110	46	0010 1110	78	0100 1110	110	0110 1110
15	0000 1111	47	0010 1111	79	0100 1111	111	0110 1111
16	0001 0000	48	0011 0000	80	0101 0000	112	0111 0000
17	0001 0001	49	0011 0001	81	0101 0001	113	0111 0001
18	0001 0010	50	0011 0010	82	0101 0010	114	0111 0010
19	0001 0011	51	0011 0011	83	0101 0011	115	0111 0011
20	0001 0100	52	0011 0100	84	0101 0100	116	0111 0100
21	0001 0101	53	0011 0101	85	0101 0101	117	0111 0101
22	0001 0110	54	0011 0110	86	0101 0110	118	0111 0110
23	0001 0111	55	0011 0111	87	0101 0111	119	0111 0111
24	0001 1000	56	0011 1000	88	0101 1000	120	0111 1000
25	0001 1001	57	0011 1001	89	0101 1001	121	0111 1001
26	0001 1010	58	0011 1010	90	0101 1010	122	0111 1010
27	0001 1011	59	0011 1011	91	0101 1011	123	0111 1011
28	0001 1100	60	0011 1100	92	0101 1100	124	0111 1100
29	0001 1101	61	0011 1101	93	0101 1101	125	0111 1101
30	0001 1110	62	0011 1110	94	0101 1110	126	0111 1110
31	0001 1111	63	0011 1111	95	0101 1111		0111 1111

- Addresses 0 and 1 are usually reserved for the Profibus DPv1 masters and must not be used to configure the Profibus DPv1 address on an Altivar 61 / 71.
- It is not advised to use address 126, which is incompatible with SSA service (Set Slave Address) and with some network configuration softwares (Sycon, ...).

Examples:

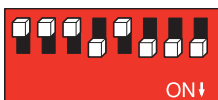

Address 23



Address 89

The address can be checked via the display terminal (see Diagnostics section).

Configuration

Control-signal configuration

There are a number of possible configurations. For more information, refer to the programming and communication parameters manuals. The configurations below are just some of the possibilities available.

Control via Profibus DPv1 in I/O profile

The command and the target come from Profibus DPv1. Control is in I/O profile.

Configure the following parameters:

Parameter	Value	Comment
Profile	I/O profile	The run command is simply obtained by bit 0 of the command word.
Target 1 configuration	Network card	The target comes from Profibus DPv1.
Command 1 configuration	Network card	The command comes from Profibus DPv1.

Configuration via the graphic display terminal or the integrated display terminal:

Menu	Parameter	Value
[1.6 - COMMAND] (CEL -)	[Profile] (CHF)	[I/O profile] (ID)
	[Ref. 1 chan] (Fr I)	[Com. opt card] (nEt)
	[Cmd channel 1] (Cd I)	[Com. opt card] (nEt)

Control via Profibus DPv1 or via the terminals in I/O profile

The command and the target both come from Profibus DPv1 or the terminals. Input LI5 at the terminals is used to switch between Profibus DPv1 and the terminals. Control is in I/O profile.

Configure the following parameters:

Parameter	Value	Comment
Profile	I/O profile	The run command is simply obtained by bit 0 of the command word.
Target 1 configuration	Network card	Target 1 comes from Profibus DPv1.
Target 1B configuration	Analog input 1 on the terminals	Target 1B comes from input AI1 on the terminals.
Target switching	Input LI5	Input LI5 switches the target (1 ↔ 1B).
Command 1 configuration	Network card	Command 1 comes from Profibus DPv1.
Command 2 configuration	Terminals	Command 2 comes from the terminals.
Command switching	Input LI5	Input LI5 switches the command.

Target 1B is connected to the functions (summing, PID, etc.) that remain active, even after switching.

Configuration via the graphic display terminal or the integrated display terminal:

Menu	Parameter	Value
[1.6 - COMMAND] (CEL -)	[Profile] (CHF)	[I/O profile] (ID)
	[Ref. 1 chan] (Fr I)	[Com. card] (nEt)
	[Cmd channel 1] (Cd I)	[Com. card] (nEt)
	[Cmd channel 2] (Cd 2)	[Terminals] (EEr)
	[Cmd switching] (CCS)	[LI5] (L I5)
[1.7 APPLICATION FUNCT.] (FUN -) [REFERENCE SWITCH.]	[Ref. 1B chan] (Fr 1b)	[AI1 ref.] (A I I)
	[Ref 1B switching] (rCb)	[LI5] (L I5)

Configuration

Control via Profibus DPv1 in Drivecom profile

The command and the target come from Profibus DPv1.
Control is in Drivecom profile.

Configure the following parameters:

Parameter	Value	Comment
Profile	Combined Drivecom profile	The run commands are in Drivecom profile, the command and the target come from the same channel.
Target 1 configuration	Network card	The command comes from Profibus DPv1.

Configuration via the graphic display terminal or the integrated display terminal:

Menu	Parameter	Value
[1.6 - COMMAND] (CLL -)	[Profile] (CHF)	[Combined] (5 17) (factory setting)
	[Ref. 1 chan] (Fr 1)	[Com. card] (nEE)

Control via Profibus DPv1 or the terminals in Drivecom profile

The command and the target both come from Profibus DPv1 or the terminals. Input LI5 at the terminals is used to switch between Profibus DPv1 and the terminals.
Control is in Drivecom profile.

Configure the following parameters:

Parameter	Value	Comment
Profile	Combined Drivecom profile	The run commands are in Drivecom profile, the command and the target come from the same channel.
Target 1 configuration	Network card	Target 1 comes from Profibus DPv1.
Target 2 configuration	Analog input 1 on the terminals	Target 2 comes from input AI1 on the terminals.
Target switching	Input LI5	Input LI5 switches the target (1 ↔ 2) and the command.

Configuration via the graphic display terminal or the integrated display terminal:

Menu	Parameter	Value
[1.6 - COMMAND] (CLL -)	[Profile] (CHF)	[Combined] (5 17)
	[Ref. 1 chan] (Fr 1)	[Com. card] (nEE)
	[Ref. 2 chan] (Fr 2)	[AI1 ref.] (R 1 1)
	[Ref 2 switching] (rFC)	[LI5] (L 15)

Configuration

Control in Drivecom profile via Profibus DPv1 and target switching at the terminals

The command comes from Profibus DPv1.

The target comes either from Profibus DPv1 or from the terminals. Input LI5 at the terminals is used to switch the target between Profibus DPv1 and the terminals.

Control is in Drivecom profile.

Configure the following parameters:

Parameter	Value	Comment
Profile	Separate Drivecom profile	The run commands are in Drivecom profile, the command and the target can come from different channels.
Target 1 configuration	Network card	Target 1 comes from Profibus DPv1.
Target 1B configuration	Analog input 1 on the terminals	Target 1B comes from input AI1 on the terminals.
Target switching	Input LI5	Input LI5 switches the target (1 ↔ 1B).
Command 1 configuration	Network card	Command 1 comes from Profibus DPv1.
Command switching	Channel 1	Channel 1 is the command channel.

Target 1B is connected to the functions (summing, PID, etc.) that remain active, even after switching.

Configuration via the graphic display terminal or the integrated display terminal:

Menu	Parameter	Value
[1.6 - COMMAND] (CEL -)	[Profile] (CHF)	[Separate] (SEP)
	[Ref. 1 chan] (Fr I)	[Com. card] (nEk)
	[Cmd channel 1] (Cd I)	[Com. card] (nEk)
	[Cmd switching] (CS)	[ch1 active] (Cd I)
[1.7 APPLICATION FUNCT.] (Fun -) [REFERENCE SWITCH.]	[Ref. 1B chan] (Fr Ib)	[AI1 ref.] (RI I)
	[Ref 1B switching] (rCb)	[LI5] (L I5)

Configuration

Configuring PZDs (communication scanner)

PZDs are configured by configuring the communication scanner.

The 8 periodic output variables are assigned by means of parameters nCA1 to nCA8. They are configured using the graphic display terminal via the [1.9 - COMMUNICATION] (C D P -) menu and [COM. SCANNER OUTPUT] (D C S -) submenu.

Note: [COM. SCANNER OUTPUT] (D C S -) submenu defines the data (parameters nCA1 to nCA8) from the PLC to the drive. An nCA parameter with a value of zero does not designate any parameter in the drive. These 8 words are described in the table below:

Parameter name	Profibus variable	Default assignment
[Scan. Out1 address] (n C A 1)	PZD1	Command word (CMD)
[Scan. Out2 address] (n C A 2)	PZD2	Speed target (LFRD)
[Scan. Out3 address] (n C A 3)	PZD3	Not used
[Scan. Out4 address] (n C A 4)	PZD4	Not used
[Scan. Out5 address] (n C A 5)	PZD5	Not used
[Scan. Out6 address] (n C A 6)	PZD6	Not used
[Scan. Out7 address] (n C A 7)	PZD7	Not used
[Scan. Out8 address] (n C A 8)	PZD8	Not used

The 8 periodic input variables are assigned by means of parameters nMA1 to nMA8. They are configured using the graphic display terminal via the [1.9 - COMMUNICATION] (C D P -) menu and [COM. SCANNER INPUT] (I C S -) submenu.

Note: [COM. SCANNER INPUT] (I C S -) submenu defines the data (parameters nMA1 to nMA8) from the drive to the PLC. An nMA parameter with a value of zero does not designate any parameter in the drive. These 8 words are described in the table below:

Parameter name	Profibus variable	Default assignment
[Scan. In1 address] (n M A 1)	PZD1	Status word (ETA)
[Scan. In2 address] (n M A 2)	PZD2	Output speed (RFRD)
[Scan. In3 address] (n M A 3)	PZD3	Not used
[Scan. In4 address] (n M A 4)	PZD4	Not used
[Scan. In5 address] (n M A 5)	PZD5	Not used
[Scan. In6 address] (n M A 6)	PZD6	Not used
[Scan. In7 address] (n M A 7)	PZD7	Not used
[Scan. In8 address] (n M A 8)	PZD8	Not used

Example of configuring PZDs via the graphic display terminal:

RDY	NET	+0.00Hz	0A
COM. SCANNER INPUT			<input type="checkbox"/>
Scan. In1 address	:		3201
Scan. In2 address	:		8604
Scan. In3 address	:		0
Scan. In4 address	:		0
Scan. In5 address	:		0
Code		Quick	<input checked="" type="checkbox"/>
Scan. In6 address	:		0
Scan. In7 address	:		0
Scan. In8 address	:		0

RDY	NET	+0.00Hz	0A
COM. SCANNER OUTPUT			<input type="checkbox"/>
Scan. Out1 address	:		8501
Scan. Out2 address	:		8602
Scan. Out3 address	:		0
Scan. Out4 address	:		0
Scan. Out5 address	:		0
Code		Quick	<input checked="" type="checkbox"/>
Scan. Out6 address	:		0
Scan. Out7 address	:		0
Scan. Out8 address	:		0

Note:

All modifications to parameters nMA1 ... nMA8 or nCA1 ... nCA8 must be made with the motor stopped. The master PLC program should be updated to take account of this modification.

Configuration

Configuring communication fault management

The response of the drive in the event of a Profibus DPV1 communication fault can be configured.

Configuration can be performed using the graphic display terminal or the integrated display terminal via the **[Network fault mgt] (CLL)** parameter in the **[1.8 - FAULT MANAGEMENT] (FLt-)** menu (**[COM. FAULT MANAGEMENT] (CLL-)** submenu).

RDY	NET	+0.00Hz	0A
COM. FAULT MANAGEMENT			<input type="checkbox"/>
Network fault mgt	:		Freewheel
CANopen fault mgt	:		Freewheel
Modbus fault mgt	:		Freewheel
Code			Quick <input type="checkbox"/>

The values of the **[Network fault mgt] (CLL)** parameter, which trigger a drive fault **[Com. network] (CnF)**, are:

Value	Meaning
[Freewheel] (YES)	: Freewheel stop (factory setting).
[Ramp stop] (rMP)	: Stop on ramp.
[Fast stop] (FSt)	: Fast stop.
[DC injection] (dCI)	: DC injection stop.

The values of the **[Network fault mgt] (CLL)** parameter, which do not trigger a drive fault, are:

Value	Meaning
[Ignore] (nO)	: Fault ignored.
[Per STT] (Stt)	: Stop according to configuration of [Type of stop] (Stt) .
[fallback spd] (LFF)	: Change to fallback speed, maintained as long as the fault persists and the run command has not been removed.
[Spd maint.] (rLS)	: The drive maintains the speed at the time the fault occurred, as long as the fault persists and the run command has not been removed.

The fallback speed can be configured in the **[1.8 - FAULT MANAGEMENT] (FLt-)** menu using the **[Fallback speed] (LFF)** parameter.

Configuration

Configuring monitored parameters

Up to 4 parameters can be selected and their value displayed in the **[1.2 - MONITORING]** menu on the graphic display terminal.

The selection is made via the **[6 - MONITORING CONFIG.]** menu (**[6.3 - CONFIG. COMM. MAP]** submenu).

Each parameter in the range **[Address 1 select] ... [Address 4 select]** can be used to select the parameter logic address. An address at zero is used to disable the function.

In the example given here, the monitored words are:

- Parameter 1 = Motor current (LCR): Logic address 3204; signed decimal format
- Parameter 2 = Motor torque (OTR): Logic address W3205; signed decimal format
- Parameter 3 = Last fault (LFT): Logic address W7121; hexadecimal format
- Disabled parameter: Address W0; default format: Hexadecimal format

RDY	NET	+0.00Hz	0A
6.3 CONFIG. COMM. MAP.			<input type="checkbox"/>
Address 1 select	:		3204
Format address 1	:		Signed
Address 2 select	:		3205
Format address 2	:		Signed
Address 3 select	:		7121
Code		Quick	<input checked="" type="checkbox"/>
Format address 3	:		Hex
Address 4 select	:		0
Format address 4	:		Hex

One of the three display formats below can be assigned to each monitored word:

Format	Range	Terminal display
Hexadecimal	0000 ... FFFF	[Hex]
Signed decimal	-32,767 ... 32,767	[Signed]
Unsigned decimal	0 ... 65,535	[Not signed]

Note: If a monitored parameter:

- has been assigned to an unknown address (e.g., 3200)
- has been assigned to a protected parameter
- has not been assigned

the value displayed in the **[COMMUNICATION MAP]** screen will be "-----" (see "Diagnostics" section).

Diagnostics

Controlling the address and speed of the bus

From the terminal, select the **[1.9 - COMMUNICATION] (C D P -)** menu (**[PROFIBUS DP] (P b S -)** submenu) to display both parameters:

- **[Address] (A d r c)**: Drive address on the bus configured on the switches
- **[Bit rate] (b d r)**: Bus speed imposed by the Profibus DPv1 master

These parameters cannot be modified.

LEDs

1.1
1.2
1.3
1.4
1.5

The Profibus DPv1 card has two LEDs, **ST** and **DX**, visible through the window on the cover of the Altivar 61 / 71:

- The status of the Profibus DPv1 card is indicated by the red **ST** (status) LED: LED 2.1.
- The status of the Profibus DPv1 communication link is indicated by the green **DX** (data exchange) LED: LED 2.2.

2.1
2.2
2.3
2.4
2.5

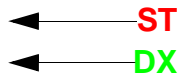

The table below gives the meaning of the various states of these two LEDs:

Red ST LED (LED 2.1)	Green DX LED (LED 2.2)	Meaning	Corrective actions in the event of malfunction
		The card has been configured and its parameters set correctly by the master.	
		The card is in Idle state, awaiting configuration.	Enter a value between 1 and 126 using the switches on the option card.
		The card is in Wait_Prm or Wait_Cfg state.	Check the connection to the Profibus DPv1 bus, start up the PLC and, if the drive has a communication card fault (CnF), reset it.
		The card is in ILF fault mode.	Check the connection between the Profibus DPv1 card and the drive.
		The card is in the "data exchange" state, and error-free data exchange is taking place.	
		No communication on the bus, no data is being exchanged.	Check the connection to the Profibus DPv1 bus, start up the PLC.

LED states

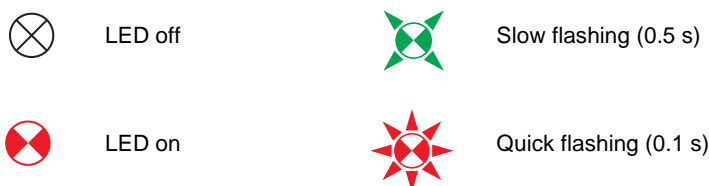

Diagnostics

Control-signal diagnostics

On the graphic display terminal, the **[1.2 - MONITORING]** menu (**[COMMUNICATION MAP]** submenu) can be used to display control-signal diagnostic information between the Altivar 61 / 71 drive and the Profibus DPv1 master:

- Active command channel
- Value of the command word (CMD) from the active command channel
- Active target channel
- Value of the target from the active target channel
- Value of the status word
- Values of four parameters selected by the user
- In the **[COM. SCANNER INPUT MAP]** submenu: PZD input values
- In the **[COM SCANNER OUTPUT MAP]** submenu: PZD output values
- In the **[CMD. WORD IMAGE]** submenu: Command words from all channels
- In the **[FREQ. REF. WORD MAP]** submenu: Frequency targets from all channels

Example of the display of communication diagnostic information

RUN	NET	+50.00Hz	80A
COMMUNICATION MAP <input type="checkbox"/>			
Command channel	:	Com. card	
Cmd value	:	000F _{Hex}	
Channel ref. active	:	Com. card	
Frequency ref	:	500.0 _{Hz}	
Status word	:	8627 _{Hex}	
Code		Quick	<input checked="" type="checkbox"/>
W3204	:	53	
W3205	:	725	
W7132	:	0000 _{Hex}	
W0	:	----- _{Hex}	
COM. SCANNER INPUT MAP			
COM SCANNER OUTPUT MAP			
CMD. WORD IMAGE			
FREQ. REF. WORD			
MAP			
MODBUS NETWORK DIAG			
MODBUS HMI DIAG			
CANopen MAP			
PROG. CARD SCANNER			

Diagnostics

Displaying the command word

The **[Command channel]** parameter indicates the active command channel.

The **[Cmd value]** parameter indicates the hexadecimal value of the command word (CMD) used to control the drive.

The **[CMD. WORD IMAGE]** submenu is used to display the hexadecimal value of the command word produced by Profibus DPv1:

- Command word CMD3 communication card channel field **[Com card cmd.]**

Displaying the frequency target

The **[Channel ref. active]** parameter indicates the active target channel.

The **[Frequency ref]** parameter indicates the value (in 0.1 Hz units) of the frequency target (LFR) used to control the drive.

The **[FREQ. REF. WORD MAP]** submenu is used to display the value (in 0.1 Hz units) of the speed target produced by Profibus DPv1:

- Speed target LFR3 Profibus DPv1 channel parameter [Com. card ref.]

Displaying the status word

The **[Status word]** parameter indicates the value of the status word (ETA).

Displaying parameters selected by the user

The four **[W....]** parameters indicate the value of the four words selected by the user.

The address and display format of these parameters can be configured in the **[6 - MONITORING CONFIG.]** menu (**[6.3 - CONFIG. COMM. MAP]** submenu) (see "Configuration" section on page [10](#)).

The value of a monitored word equals "-----" if:

- Monitoring has not been activated (address equals W0)
- The parameter is protected
- The parameter is not known (e.g., W3200)

Diagnostics

Displaying PZDs (communication scanner)

In the **[1.2 - MONITORING] (SUP -)** menu:

- The **[COM. SCANNER INPUT MAP] (ISA -)** submenu is used to display the value of the 8 input PZDs (communication scanner input parameters NM1 to NM8).

- The **[COM SCANNER OUTPUT MAP] (OSA -)** submenu is used to display the value of the 8 output PZDs (communication scanner output parameters NC1 to NC8).

Configuration of these periodic parameters is described in the "Configuration" section.

Example of displaying PZDs on the graphic display terminal:

RUN	NET	+50.00Hz	80A
COM. SCANNER INPUT MAP <input type="checkbox"/>			
Com Scan In1 val.	:		34359
Com Scan In2 val.	:		600
Com Scan In3 val.	:		0
Com Scan In4 val.	:		0
Com Scan In5 val.	:		0
Code		Quick	<input checked="" type="checkbox"/>
Com Scan In6 val.	:		0
Com Scan In7 val.	:		0
Com Scan In8 val.	:		0

RUN	NET	+50.00Hz	80A
COM SCANNER OUTPUT MAP			
Com Scan Out1 val.	:		15
Com Scan Out2 val.	:		598
Com Scan Out3 val.	:		0
Com Scan Out4 val.	:		0
Com Scan Out5 val.	:		0
Code		Quick	<input checked="" type="checkbox"/>
Com Scan Out6 val.	:		0
Com Scan Out7 val.	:		0
Com Scan Out8 val.	:		0

In this example, only the first two parameters have been configured (default assignment).

[Com Scan In1 val.]	=	[34343] Status word = 34359 = 16#8637	→ Drivecom status "Operation enabled", reverse operation, speed reached.
[Com Scan In2 val.]	=	[600] Output speed = 600	→ 600 rpm
[Com Scan Out1 val.]	=	[15] Command word = 15 = 16#000F	→ "Enable operation" (Run) command
[Com Scan Out2 val.]	=	[598] Speed target = 600	→ 598 rpm

Diagnostics

Communication faults

Profibus DPv1 communication faults are displayed by the red RD indicator of the Profibus DPv1 card.

In factory settings, a Profibus DPv1 communication fault triggers a resettable drive fault **[Com. network] (CnF)** and a freewheel stop.

The response of the drive in the event of a Profibus DPv1 communication fault can be changed (see "Configuring communication fault management"):

- Drive fault **[Com. network] (CnF)** (freewheel stop, stop on ramp, fast stop or DC injection stop).
- No drive fault (stop, maintain, fallback).

The fault management is described in the user's manual "Communication parameters", chapter "Communication monitoring":

- After initialization (power up), the drive checks that at least one of the command or target parameters has been written once via Profibus DPv1.
- Then, if a Profibus DPv1 communication fault occurs, the drive reacts according to the configuration (stop, maintain, fallback ...).

The origin of the last Profibus DPv1 communication fault can be displayed by the parameter **[Com. network] (CnF)** :

Value	Description of the values of the parameter [Com. network] (CnF)
0	No fault
1	Time out on the reception of the periodic variables addressed to the drive. This time out is adjustable by the network configuration software..
2	Identification error between the Profibus DPv1 card of the drive and the Profibus DPv1 master.
3	Identification error of the Profibus DPv1 card of the drive (hardware problem).

The parameter **[Com. network] (CnF)** is displayed on the display terminal (graphic only): **[1.10 DIAGNOSTICS] (DGT-)** menu, **[MORE FAULT INFO] (AFI-)** submenu.

Card fault

The **[Option int link] (ILF)** fault appears when there are serious problems:

- Hardware problem on the Profibus DPv1 card itself.
- Dialog faults between the option card and the drive.

It is not possible to configure the behavior of the drive in the event of a **[Option int link] (ILF)** fault, the drive stops in freewheel. This type of fault cannot be reset.

Two parameters display the origin of the last **[Option int link] (ILF)** faults :

- **[Internal link fault 1] (ILF1)** displays the error that occurred on option card no. 1 (directly mounted on the drive),
- **[Internal link fault 2] (ILF2)** displays the error that occurred on option card no. 2 (mounted on the option card no. 1),

The parameter **[Internal link fault 1] (ILF1)** and **[Internal link fault 2] (ILF2)** are displayed on the display terminal (graphic only): **[1.10 DIAGNOSTICS] (DGT-)** menu, **[MORE FAULT INFO] (AFI-)** submenu.

Value	Description of the values of the parameter Internal link fault 1] (ILF1) and [Internal link fault 2] (ILF2)
0	No fault
1	Loss of internal communication with the drive
2	Hardware malfunction detected
3	Error in the EEPROM checksum
4	Faulty EEPROM
5	Faulty Flash memory
6	Faulty RAM memory
7	Faulty NVRAM memory
8	Faulty analog input
9	Faulty analog output
10	Faulty logic input
11	Faulty logic output
101	Unknown card
102	Dialog faults between the option card and the drive
103	Dialog time out between the option card and the drive

Software setup of DPv1 messaging

Profibus DPv1 protocol

Data is exchanged according to the master-slave principle.

Only the master can initialize communication. The slaves behave like servers responding to requests from masters.

Several masters can coexist on the same bus. In this case, the slave I/O can be read by all the masters. However, a single master has write access to the outputs. The number of data items exchanged is defined at the time of configuration.

A GSD file contains the configuration information for the Altivar 61 / 71 with Profibus DPv1. This file is used by the PLC during the configuration phases.

The GSD file is unique to the whole Altivar 61 / 71 range. It does not describe the drive parameters, just the communication information. This file appears on the CD-ROM supplied with the drive.

The Profibus DPv1 card for Altivar 61 / 71 drives only supports supports types 3, 4, 5 and 8 PPO format (Parameter-Process Data-Object) cyclic frames.

	PKW length (word)				PZD length (word)									
	1	2	3	4	1	2	3	4	5	6	7	8	9	10
PPO type 1														
PPO type 2														
PPO type 3														
PPO type 4														
PPO type 5														
PPO type 6														
PPO type 7														
PPO type 8														

PPO cyclic frames contain the periodic variables that are used for 2 types of service:

- I/O exchanges (PZD)
- Aperiodic exchanges (PKW) for parameter setting, configuration and diagnostics

PKW aperiodic exchanges are included in the cyclic frames and do not require special frames. An aperiodic exchange is used to read or write a parameter. The Altivar 61 / 71 PKW service does not conform to Profidrive.

Software setup of DPv1 messaging

Several types of DPv1 master can currently be used:

- Some masters require the exclusive use of slot 1, which requires an **indirect access mechanism**.
- Others allow the data to be accessed directly using **direct access**.

Indirect access (use of SLOT 1 only)

To use Profibus DPv1 messaging the following sequence must be used:

Step 1: The Profibus DPv1 master must firstly give the slave the modbus offset of the parameter to be read or written:

	Function	Slot	Index	Length	Data	Data
	0x5F	0x01	0xE9	0x02	Offset	Offset
Example with ACC (offset 9001)	0x5F	0x01	0xE9	0x02	0x2329	

Step 2 (read): The Profibus DPv1 master must give the length to be read starting from the offset indicated in step 1:

	Function	Slot	Index	Length	Data	Data
	0x5E	0x01	0xEA	<0x3C		
Example with ACC (length 1 word: length = 0x2 bytes)	0x5E	0x01	0xEA	0x02		

The response to this request contains the data to be read.

Step 2 (write): The Profibus DPv1 master must give the value to be written at the offset indicated in step 1:

	Function	Slot	Index	Length	Data	Data
	0x5F	0x01	0xEA	0x02	Value	Value
Example with ACC (write at 1.6 s)	0x5F	0x01	0xEA	0x02	0x0010	

To check what offset has been configured, it is possible to interrogate the slave:

Function	Slot	Index	Length	Data	Data
0x5E	0x01	0xE9	0x02	Offset	Offset

Software setup of DPv1 messaging

Direct access (using the SLOT INDEX)

Direct access is available from slot 2 on:

Read

	Function	MSB slot	LSB index	Length	Data	Data
Example with ACC (offset 9001 = 0x2329)	0x5E	0x23	0x29	0x02		

The response to this request contains the data to be read:

	Function	MSB slot	LSB index	Length	Data	Data
Value read	0x5E	0x23	0x29	0x02	Value	

Write

	Function	MSB slot	LSB index	Length	Data	Data
Example with ACC (offset 9001 = 0x2329)	0x5F	0x23	0x29	0x04	0x0011	

Irrespective of the type of access used (direct or indirect)

Read report:

	Function	Slot	Index	Length	Data	Data
	0xDF	0x80	0xXX	0xYY	0	

Write report:

	Function	Slot	Index	Length	Data	Data
	0xDE	0x80	0xXX	0xYY	0	

With error types:

0xXX - 0xYY	Type of error	Meaning
0xC2 - 0x00	Resource	SAP not available (in use)
0xB7 - 0x00	Access	Incorrect length (= 0 or > 60)
0xA0 - 0x00	Application	Read failed (time out, etc)

Software setup of DPv0 messaging

Output PZDs

The first eight bytes contain an aperiodic request (PKW) to write or read a parameter.

The remaining 20 bytes contain the output PZDs (written from the Profibus master), of which only PZD1 to PZD8 are significant.

1	2	3	4	5	6	7	8	9	10	11	12	13	14
PKW								PZD1		PZD2		PZD3	
PKE		0	R/W	PWE				NC1		NC2		NC3	
15	16	17	18	19	20	21	22	23	24	25	26	27	28
PZD4		PZD5		PZD6		PZD7		PZD8		PZD9		PZD10	
NC4		NC5		NC6		NC7		NC8		Not used		Not used	

PKW request:	
PKE	Parameter logic address
RIW	Request code 0: No request 1: Read 2: Write
PWE	For a read request: Not used For a write request: Parameter value

Cyclic control and adjustment parameters:

PZD1: Communication scanner output word 1 (NC1)

PZD2: Communication scanner output word 2 (NC2)

PZD3: Communication scanner output word 3 (NC3)

PZD4: Communication scanner output word 4 (NC4)

PZD5: Communication scanner output word 5 (NC5)

PZD6: Communication scanner output word 6 (NC6)

PZD7: Communication scanner output word 7 (NC7)

PZD8: Communication scanner output word 8 (NC8)

The default assignment of the periodic output data is:

- PZD1 = Command word
- PZD2 = Speed target
- PZD 3 to PZD 10 = Not used

1	2	3	4	5	6	7	8	9	10	11	12	13	14
PKW								PZD1		PZD2		PZD3	
PKE		0	R/W	PWE				Command word		Speed target		Not used	
15	16	17	18	19	20	21	22	23	24	25	26	27	28
PZD4		PZD5		PZD6		PZD7		PZD8		PZD9		PZD10	
Not used		Not used		Not used		Not used		Not used		Not used		Not used	

The assignment of PZDs is described in the Configuration section.

How to display the value of the PZDs is described in the "Diagnostics" section.

Software setup of DPv0 messaging

Input PZDs

The first eight bytes contain the response (PKW) to the aperiodic read/write request.
The remaining 20 bytes contain the input PZDs (read mode), of which only PZD1 to PZD8 are significant.

1	2	3	4	5	6	7	8	9	10	11	12	13	14
PKW								PZD1		PZD2		PZD3	
PKE		0	R/W/N	PWE				NM1		NM2		NM3	

15	16	17	18	19	20	21	22	23	24	25	26	27	28
PZD4		PZD5		PZD6		PZD7		PZD8		PZD9		PZD10	
NM4		NM5		NM6		NM7		NM8		Not used		Not used	

PKW request	
PKE	Parameter logic address
R/W/N	Response code 0: No request 1: Successful read report 2: Successful write report 7: Error report
PWE	For a successful request: Parameter value For an incorrect request: 0: Incorrect address 1: Write access denied

Cyclic monitoring parameters:

PZD1: Communication scanner input word 1 (NM1)

PZD2: Communication scanner input word 2 (NM2)

PZD3: Communication scanner input word 3 (NM3)

PZD4: Communication scanner input word 4 (NM4)

PZD5: Communication scanner input word 5 (NM5)

PZD6: Communication scanner input word 6 (NM6)

PZD7: Communication scanner input word 7 (NM7)

PZD8: Communication scanner input word 8 (NM8)

The default assignment of the periodic input data is:

- PZD1 = Status word (ETA)
- PZD2 = Output speed (RFRD)
- PZD 3 to PZD 10 = Not used

1	2	3	4	5	6	7	8	9	10	11	12	13	14
PKW								PZD1		PZD2		PZD3	
PKE		0	R/W	PWE				Status word		Output speed		Not used	

15	16	17	18	19	20	21	22	23	24	25	26	27	28
PZD4		PZD5		PZD6		PZD7		PZD8		PZD9		PZD10	
Not used		Not used		Not used		Not used		Not used		Not used		Not used	

The assignment of PZDs is described in the Configuration section on page 11.
How to display the value of the PZDs is described in the "Diagnostics" section.

Software setup of DPv0 messaging

PKW aperiodic service

The PKW service, consisting of PKE, R/W, R/W/N, and PWE, enables aperiodic access to Altivar 71 parameters in read and write mode.

Output PKWs

PKE

Parameter logic address

R/W

0: No request
1: Read
2: Write

One-off read and write requests can be triggered continuously while R/W equals 1 or 2.

Note:

Values other than 0, 1 and 2 should not be used. In particular, the values 16#0052 and 16#0057 must not be used, as these are reserved for compatibility with the Altivar 58/58F.

PWE

If write: Value to be written

Input PKWs

PKE

Copies the output PKE value

R/W/N

0: No request
1: Correct read operation
2: Correct write operation
7: Read or write error

PWE

- If correct read operation: Parameter value. This can be limited by the drive if the maximum value is exceeded by the write operation.
- If correct write operation: Value of the write PWE
- If there is an error:
0: Incorrect address
1: Write operation refused

Note:

The parameters in the output PZDs should not be changed by the PKW service. Parameters linked to output PZDs should not be changed by the PKW service. Example: The speed target and the frequency target.

Software setup of DPv0 messaging

Examples of PKW aperiodic exchanges

Example of aperiodic write operation: Acceleration time ACC (address 9001) = 10 s, unit 0,1s (values in hexadecimal format).

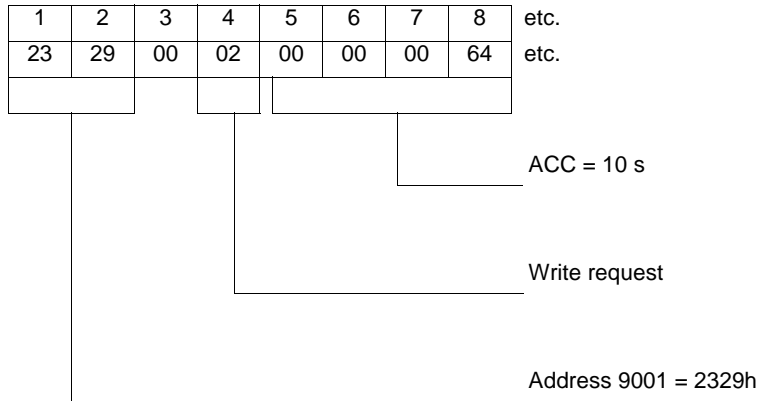

The positive response is identical to the write request, aperiodic part (bytes 1 to 8).

Example of negative response:

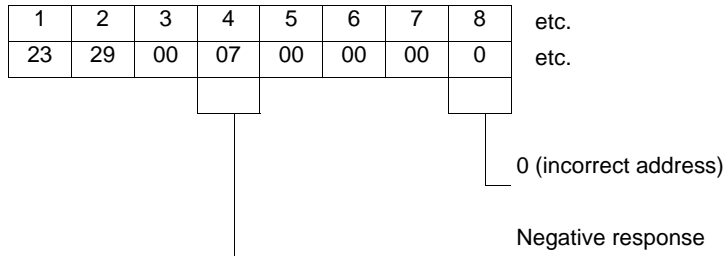

Software setup using PL7

Correspondence between cyclic data and PL7 PRO words

In PL7, cyclic exchanges between the Profibus DPv1 master (e.g., TSX Premium PLC + TSX PBY100 module) and the Altivar 61 / 71 take the form of input words %IWxy.0.k and output words %QWxy.0.k, where "x" = number of the PLC rack and "y" = location of the Profibus DPv1 module in the PLC rack.

Profibus	PL7 output word	Altivar 61 / 71 parameter
PKW	%QWxy.0	PKE
	%QWxy.0.1	R/W
	%QWxy.0.2	Not used
	%QWxy.0.3	PWE
PZD1	%QWxy.0.4	NC1
PZD2	%QWxy.0.5	NC2
PZD3	%QWxy.0.6	NC3
PZD4	%QWxy.0.7	NC4
PZD5	%QWxy.0.8	NC5
PZD6	%QWxy.0.9	NC6
PZD7	%QWxy.0.10	NC7
PZD8	%QWxy.0.11	NC8
PZD9	%QWxy.0.12	Not used
PZD10	%QWxy.0.13	

Profibus	PL7 input word	Altivar 71 parameter
PKW	%IWxy.0	PKE
	%IWxy.0.1	R/W/N
	%IWxy.0.2	Not used
	%IWxy.0.3	PWE
PZD1	%IWxy.0.4	NM1
PZD2	%IWxy.0.5	NM2
PZD3	%IWxy.0.6	NM3
PZD4	%IWxy.0.7	NM4
PZD5	%IWxy.0.8	NM5
PZD6	%IWxy.0.9	NM6
PZD7	%IWxy.0.10	NM7
PZD8	%IWxy.0.11	NM8
PZD9	%IWxy.0.12	Not used
PZD10	%IWxy.0.13	

Default configuration of the periodic variables

Profibus		PL7 output word	Altivar 61 / 71 parameter
PKW	PKE	%QWxy.0	
	R/W	%QWxy.0.1	
	Not used	%QWxy.0.2	
	PWE	%QWxy.0.3	
PZD1		%QWxy.0.4	Command word (CMD)
PZD2		%QWxy.0.5	Speed target (LFRD)
PZD3		%QWxy.0.6	Not used
PZD4		%QWxy.0.7	Not used
PZD5		%QWxy.0.8	Not used
PZD6		%QWxy.0.9	Not used
PZD7		%QWxy.0.10	Not used
PZD8		%QWxy.0.11	Not used
PZD9		%QWxy.0.12	Not used
PZD10		%QWxy.0.13	Not used

Profibus		PL7 input word	Altivar 61 / 71 parameter
PKW	PKE	%IWxy.0	
	R/W	%IWxy.0.1	
	Not used	%IWxy.0.2	
	PWE	%IWxy.0.3	
PZD1		%IWxy.0.4	Status word (ETA)
PZD2		%IWxy.0.5	Output speed (RFRD)
PZD3		%IWxy.0.6	Not used
PZD4		%IWxy.0.7	Not used
PZD5		%IWxy.0.8	Not used
PZD6		%IWxy.0.9	Not used
PZD7		%IWxy.0.10	Not used
PZD8		%IWxy.0.11	Not used
PZD9		%IWxy.0.12	Not used
PZD10		%IWxy.0.13	Not used

Example with SIMATIC Manager (STEP7)

Configuration example:

In the SIMATIC project:

- Add GSD file corresponds to VW3 A3 307 S371 card.
- Add ATV71-PROFIBUS-DPV1-Modular to the Profibus address configured by the switch of the card.
- Select the PPO choosen.

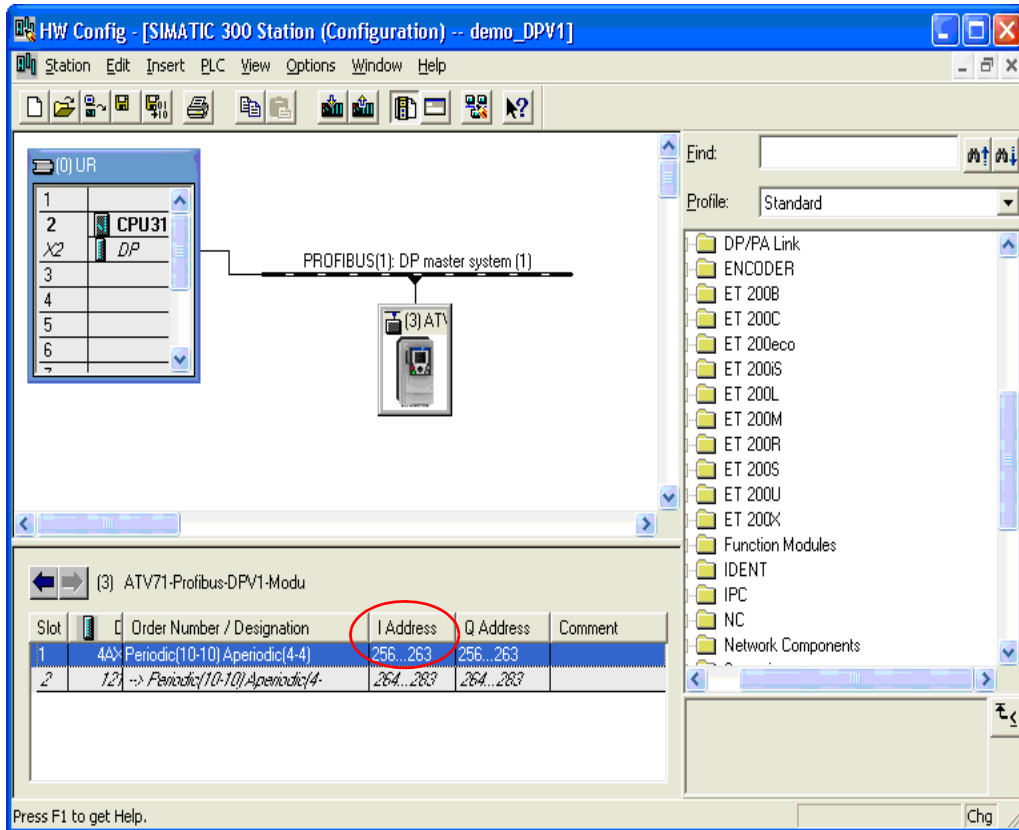

- Write down the PLC memory address where ATV61 / 71 periodics are mapped (see figure above red circle). This address area is used to setup DPv1 messaging.

Example with SIMATIC Manager (STEP7)

Messaging example by indirect access:

Select a function bloc "SFC58" dedicated for DPV1 writing (indirect access - slot 1) and complete the fields. Follow the instructions given in the section Indirect access page [24](#).

LADDR field must correspond to the PLC memory address where ATV61 / 71 periodics are mapped (16#100 corresponds to 256 in decimal).

RECNUM field corresponds to the index (0XE9 ou 0XEA) in accordance with indirect mechanism already described.

RECORD filed corresponds to the ATV61 / 71 memory offset.

Writing example

Reading example

Network: 1

Network: 1

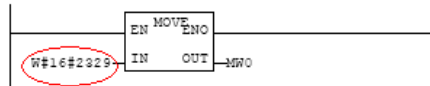
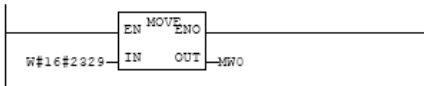

Network: 2

Network: 2

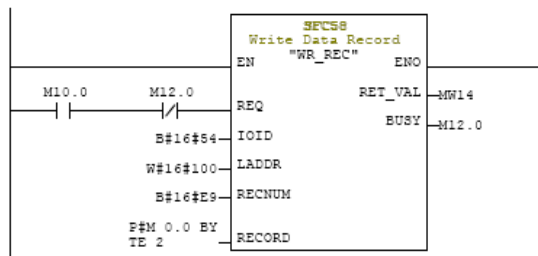
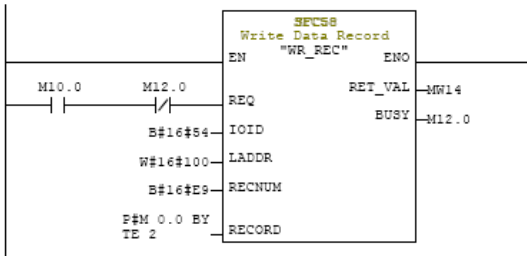

Network: 3

Network: 3

